



Power Factor Controller RVT

The smart PFC for automatic capacitor bank

Distinct features

Power factor correction for both balanced and unbalanced loads

In modern day installations, unbalanced loads are increasingly common, especially in residential or commercial buildings. RVT addresses your power factor issues from both single phase loads (L-L or L-N) and three phase balanced/unbalanced loads. RVT is capable of compensation to each phase individually or compensation to three phases globally. Another distinct feature of RVT is individual phase measurements and energy calculations.

Complete three phase measurements

- Active power (kW) - 3ph/1ph
- Apparent power (kVA) -3ph/1ph
- Reactive power (kvar) -3ph/1ph
- Reactive power (kvar) to reach the target $\cos \phi$ -3ph/1ph
- Voltage (V) -3ph/1ph
- Current (A) -3ph/1ph
- $\cos \phi$ -3ph/1ph
- Total Harmonic Distortion on Voltage/Current : THD V/I (%)
- Voltage/Current Harmonics : H2 up to H49 (%-spectrum)

Touch Screen

3.5 inch colorful QVGA touch screen eases your parameter settings.

Ethernet connection

With ABB PQ Link software, you may easily plug an RJ-45 to RVT and communicate with the controller through a 10/100BASE-T interface anywhere in the world.

USB connection

RVT supports USB2.0 connection; which makes it possible to connect to a computer via a widely used USB cable to access all RVT parameters.

Up to 8 Temperature alarm outputs

RVT can monitor 8 hot spots in your bank through eight daisy-chain connected temperature probes.

Real time clock

RVT real time clock tracks and logs date and moment of each alarm and event.

Hardware and software lock

Both hardware and software locks are equipped in the RVT for bank setting protections from any unauthorized access.

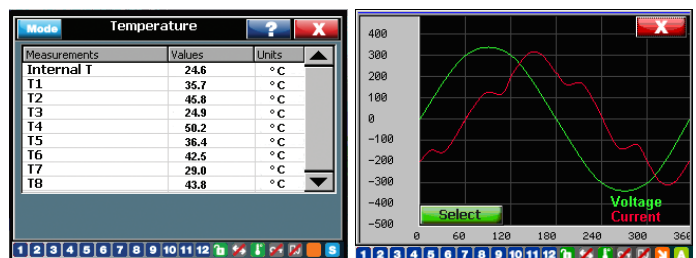
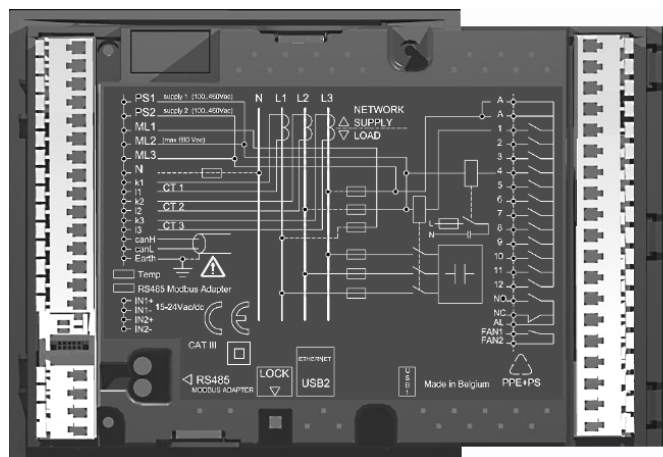

Measurements	Values	Units
Internal T	24.6	°C
T1	35.7	°C
T2	45.8	°C
T3	24.9	°C
T4	50.2	°C
T5	36.4	°C
T6	42.5	°C
T7	29.0	°C
T8	43.8	°C

Other powerful features

RVT is also a MV and HV bank controller

By connecting a PT to the RVT voltage measurements inputs, and setting the proper [V scaling] according to the PT ratio, the RVT is able to control a MV or HV capacitor bank just like a LV capacitor bank.



Easy commissioning

The fully automatic set-up of the RVT parameters totally eases the bank commissioning process.

Menu navigation

The clever organization of menus and sub-menus ensures menu navigation easy and intuitive.

Guided navigation and programming

Online help information guides you step by step in the menu navigation and RVT programming.

Communication

RVT has versatile communication interfaces: in addition to Ethernet 10/100BASE-T and USB2.0, the RVT supports RS485 connection as well. All parameters settings and measurements are accessible remotely.

Fully automatic set-up

C/k (sensitivity), active outputs, switching sequence and phase shift can be automatically set-up.

Programmable protection thresholds

Programmable thresholds allow you to protect the capacitor bank against over- and under-voltage, over-temperature and excessive harmonic distortions.

Network information and capacitor bank monitoring

The RVT computes and displays network and capacitor bank information such as voltage, current, harmonics spectra and much more.

Multi-language support

The RVT allows you to choose its working language between English, French, German, Spanish and Chinese.

High ambient temperature rating

The RVT is suitable for harsh ambient environments thanks to its maximum ambient temperature rating of 70°C.

Multi-voltage and multi-frequency

The RVT may be connected to network voltages in the range 100-460Vac, 50/60Hz. RVT's measurement voltage is up to 690Vac without connecting any additional PT.

Works with 5A and 1A CT's

Both 5A and 1A CT's may be connected to the RVT.

Digital inputs

Two digital inputs can be used for day/night power factor and external alarm respectively.

Two alarm relay outputs and fan / warning output

RVT has two alarm relay outputs (NO and NC) and a FAN/Warning relay output.

On-line help

A click to this button  at the right top of the touch screen, it will give you an instant access to a online help system which will guide you through all RVT operation/ commissioning step by step.

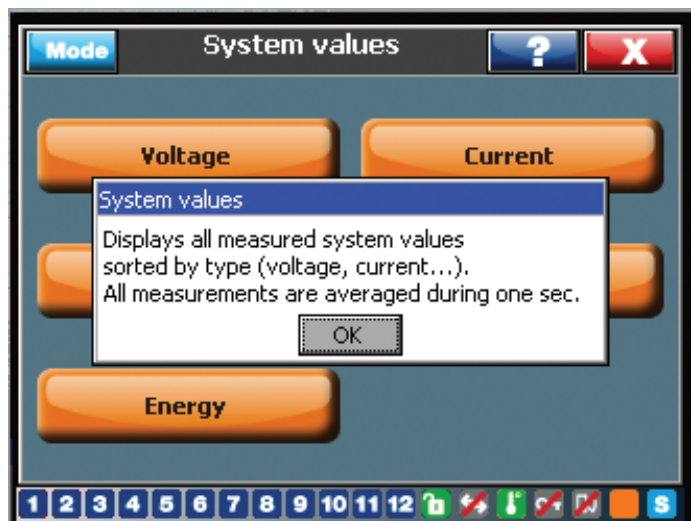

Touch screen

Ease your menu navigation

The touch screen eases capacitor bank setting in an intuitive way and provides a versatile interactive interface to users.

Start screen



Harmonics spectrum display

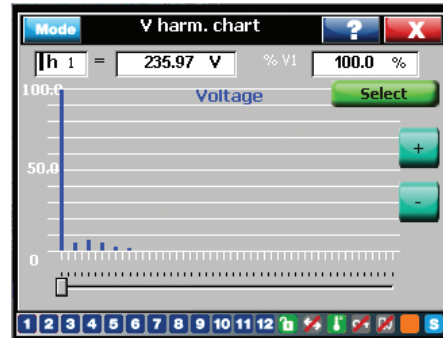

select measurements to display

zoom in / out the chart

A typical setting screen

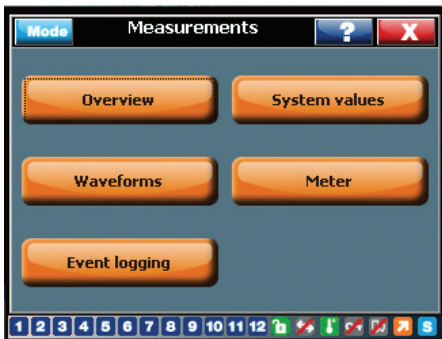

title bar

Setting area

Status bar

Legends

- | | | | |
|--|------------------------|--|--------------------|
| | active output | | temperature alarm |
| | unlock (software) | | temperature normal |
| | locked (software) | | locked (hardware) |
| | communication locked | | unlock (hardware) |
| | communication unlocked | | alarm active |
| | warning | | alarm inactive |
| | on demand | | mode change |
| | off demand | | online help |
| | manual mode | | close window |
| | setting mode | | validation |
| | auto mode | | next page |

Numeric keypad



Easy commissioning

A typical auto commissioning process is illustrated below.

1. Select "Settings" in the start screen



2. Validate „Commissioning“

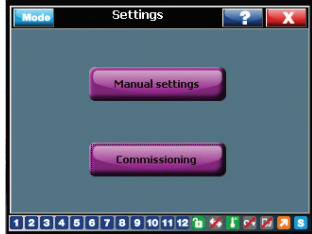

3. Validate „Automatic“



4. Press OK

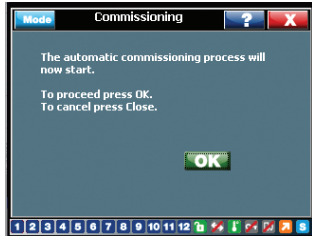

5. Press OK



6. Select the type of connection and press OK



7. Press OK



8. Lock or unlock the „Bank Settings“ and press OK

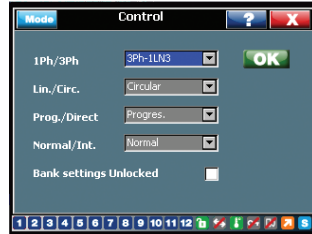

9. Press OK



10. Press OK



11. Press OK



12. Input CT scaling: 50

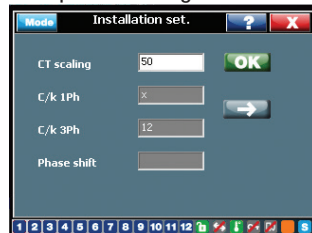

13. Press OK



14. Press OK

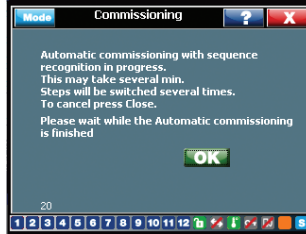

19. Press OK



20. Press OK



15. Press OK



21. Automatic commissioning completed



16. Press OK



17. Press OK



18. Press OK



Connection types

The type of connection defines ways of RVT measuring current and voltage. RVT allows eight different types of connection topologies based on the type of installation and number of current and voltage transformers:

3Ph - 3 LN 3

1: one CT connection
2: two CTs connections
3: three CTs connections

LN: V measurement between L and N
LL: V measurement between phases

1: one V measurement
3: three V measurements

1Ph: single phase network (L-N or L-L)
3Ph: three phase network

Detailed wiring and direct current & voltage measurements capabilities are shown on next page, which facilitates the selection of different types of connection in terms of installation types and requirements on voltage and current measurements.

For RVT6 and RVT12, only type 1, 2 and 3 are available; RVT12-3P is able to connect in all eight different types of connection.

Type	RVT6/RVT12	RVT12-3P
Type 1	1Ph-1LL1	1Ph-1LL1
Type 2	3Ph-1LL1	3Ph-1LL1
Type 3	3Ph-1LN1	3Ph-1LN1
Type 4	N.A.	3Ph-3LL3
Type 5	N.A.	3Ph-3LL2
Type 6	N.A.	3Ph-3LN3
Type 7	N.A.	3Ph-1LL3
Type 8	N.A.	3Ph-1LN3

Before commissioning (both auto and guided), please make sure that:

- RVT is unlocked (both soft and hardware lock)
- RVT is in SET mode
- CTs are properly connected

Parameters to set	Guided commissioning	Auto commissioning
1Ph/3Ph (CT and voltage connection type)	X	X
Phase rotation only	X	O
CT ratio before phase shift	X	X
CT redirection	X	O
Phase shift	X	O
PT ratio (for MV banks)	X	X
V Nominal	X	X
ON-Delay	X	O
OFF-Delay	X	O
Output status and size	X	O
Q step (minimal step size)	X	O
C/k (start current)	X	O
Target cos ϕ	X	X

X: Manual setting required

O: Automatic setting

Connection types

Single and three phase PFC control types

Connection type		RVT 12 - 3P	RVT 6 / RVT 12	Phase shift adjustment	Voltages			Currents				Compensation type					
Name	Schematics	Connection	Connection		L12	L23	L31	L1N	L2N	L3N	L1	L2	L3	N	Full C3 ¹	Full C1 ²	Mixed C3+C1
1Ph-1LL1				0° by default (see phase shift table)	-	M e a s u r e d	-	-	-	M e a s u r e d	-	-	-	-	yes	-	-
3Ph-1LL1				90° by default (see phase shift table)	-	M e a s u r e d	-	-	-	M e a s u r e d	-	-	-	yes	-	-	-
3Ph-1LN1				0° by default (see phase shift table)	-	-	-	M e a s u r e d	-	-	-	-	-	yes	-	-	-
3Ph-3LL3			-	0° by default (Adjust - phase rotation - CT redirection)	M e a s u r e d	M e a s u r e d	M e a s u r e d	C a l c u l a t e d	C a l c u l a t e d	C a l c u l a t e d	M e a s u r e d	M e a s u r e d	M e a s u r e d	C a l c u l a t e d	yes	yes	yes
3Ph-3LL2			-	0° by default (Adjust - phase rotation - CT redirection)	M e a s u r e d	M e a s u r e d	M e a s u r e d	C a l c u l a t e d	C a l c u l a t e d	C a l c u l a t e d	M e a s u r e d	M e a s u r e d	C a l c u l a t e d	(3)	yes	yes	yes
3Ph-3LN3			-	0° by default (Adjust - phase rotation - CT redirection)	C a l c u l a t e d	C a l c u l a t e d	C a l c u l a t e d	M e a s u r e d	M e a s u r e d	M e a s u r e d	M e a s u r e d	M e a s u r e d	C a l c u l a t e d	yes	yes	yes	yes
3Ph-1LL3			-	0° by default (Adjust - CT redirection)	-	M e a s u r e d	-	-	-	M e a s u r e d	M e a s u r e d	M e a s u r e d	C a l c u l a t e d	yes	yes	yes	yes
3Ph-1LN3			-	0° by default (Adjust - CT redirection)	-	-	-	M e a s u r e d	-	-	M e a s u r e d	M e a s u r e d	C a l c u l a t e d	yes	yes	yes	yes

¹ C3: three-phase capacitor control

² C1: single-phase capacitor control

Accessories

RS485 Modbus adapter

All RVT controllers are Modbus communication enabled. The Modbus adapter is an optional item which allows communication with a monitoring system.

All RVT parameters are available (including harmonic spectrum and tables) through an RS485 Modbus adapter. All RVT parameters are accessible and locking parameters allows limiting their access through the Modbus communication only.

The RVT RS485 interface (3.3V power supply) is not compatible with previous RS485 adapter (5V power supply).

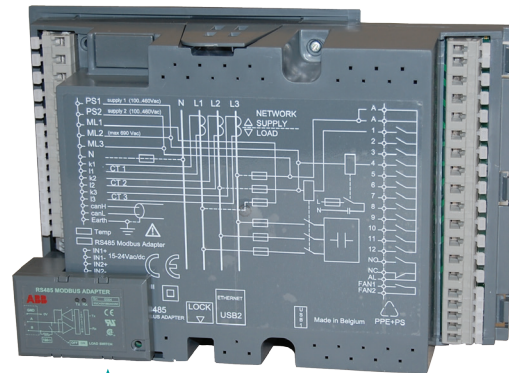

External probes for temperature measurements

Up to eight temperature probes may be connected to the RVT. The eight temperature probes are connected in daisy chain. Connection details are shown in the manual. The RVT will close the fan relay if any of the eight temperature thresholds is exceeded. Information on temperature may be recorded with the event logging function.

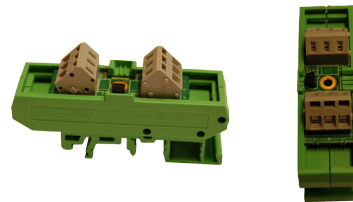

IP54

The RVT front plate offers an IP43 protection degree in standard version.

The gasket accessory enhances the standard RVT protection degree to IP54.



Wiring diagram

Base model

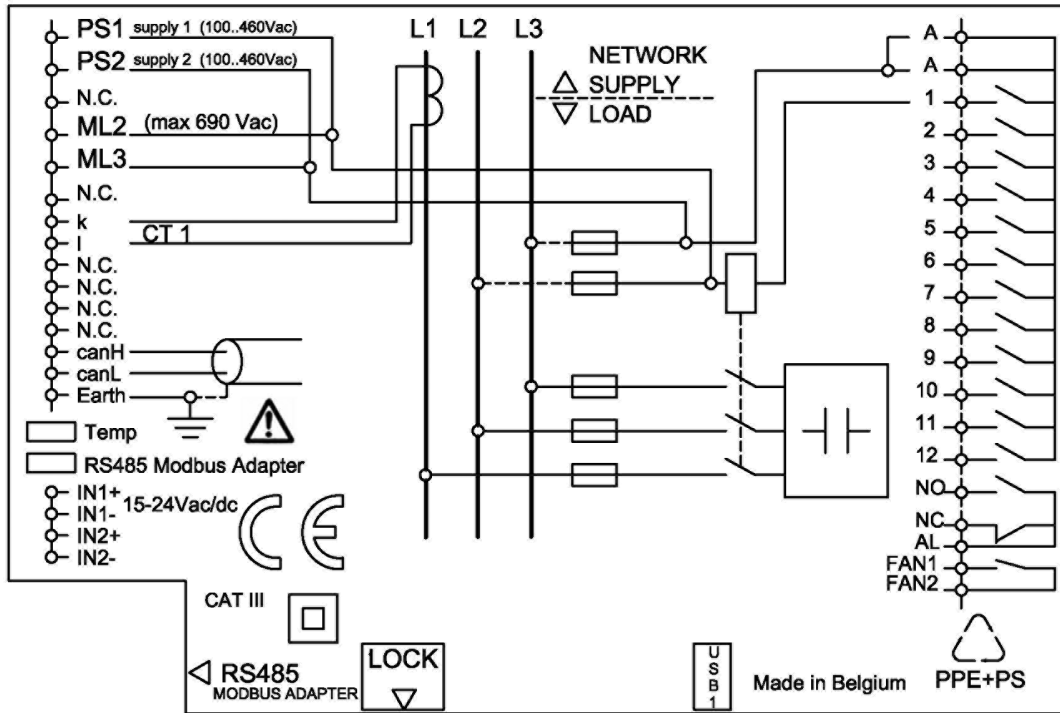

PS1 - PS2: power supply

ML1-3:
voltage measurements

N: neutral connection

k1-3, I1-3: CT connection

canH, canL : CAN bus

Earth: grounding

Temp: temperature probe
connection

RS485:
RS485 adapter interface

N1-2+/- digital inputs

A: common source
for output relay

1-12: outputs

NO/NC: output contacts
of alarm relay

AL: common source for
alarm relay

FAN/Warning 1-2:
FAN output relay

USB: USB connection

RJ45: Ethernet

LOCK: hardware lock

Three-phase model

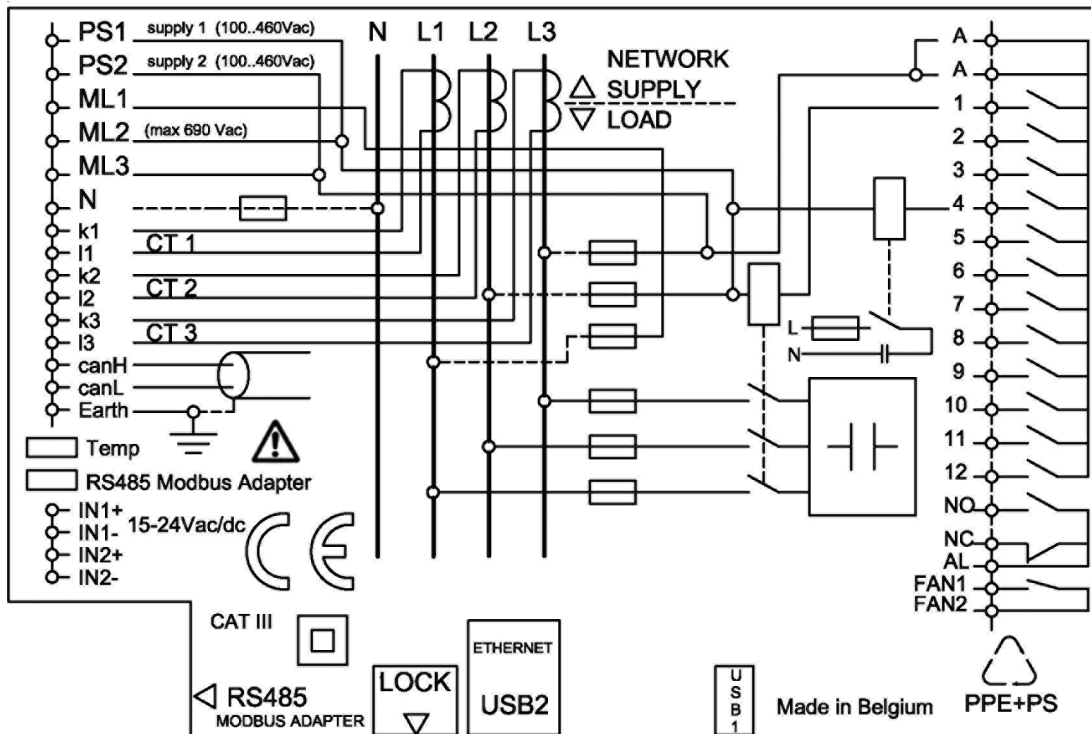

Technical specifications

Measuring system	Micro-processor system for balanced three-phase/single-phase networks and unbalanced network. Individual phase power factor control is available.
Supply voltage	From 100Vac up to 460 Vac.
Consumption	15 VA max.
Connection type for measuring circuit and power supply	Phase-phase or phase-neutral for balanced and unbalanced network.
Voltage tolerance	±10% on indicated supply voltages.
Measurement category (according to IEC 61010-1)	CAT III.
Voltage measurement	Up to 690Vac or higher with voltage transformer.
Accuracy	±1% full scale.
Frequency range	45 or 65 Hz (automatic adjustments to network frequency).
Current input	5A or 1A (RMS) (class 1 C.T.).
Current input impedance	<0.1 Ohm.
Power outage release	Automatic disconnection of all capacitors in case of a power outage longer than 20ms.
Number of outputs	RVT6/RVT12 Base Model: programmable up to 6 or 12 outputs. RVT12-3P Three Phase Model: programmable up to 12 outputs.
Output contact rating	Max. continuous current: 1.5A (ac) – 0.3A (110V dc). Max. peak current: 5A. Max. voltage: 440 Vac. Terminal A-A are rated for a continuous current of 18A (9A/terminal).
Alarm contact rating (voltage free contact)	One normally closed contact and one normally open contact. Max. continuous current: 1.5A (ac). Rated voltage: 250Vac (max. breaking voltage: 440Vac).
Fan contact rating (voltage free contact)	Normally open contact. Max. continuous current: 1.5A (ac). Rated voltage: 250Vac (max. breaking voltage: 440Vac).
Power factor setting	From 0.7 inductive to 0.7 capacitive.
Starting current setting (C/k)	0.01 to 5A. Automatic measurement of C/k.
Switching sequences	1:1:1:1:1:.....:1 - 1:2:2:2:2:.....:2 - 1:2:4:4:4:.....:4 1:2:4:8:8::8 - 1:1:2:2:2:.....:2 - 1:1:2:4:4:.....:4 1:1:2:4:8:.....:8 - 1:2:3:3:3:.... :3 - 1:2:3:6:6:.....:6 1:1:2:3:3:.....:3 - 1:1:2:3:6:.....:6 and any other customer programmable sequence.
Modbus baud rate	300 - 600 - 1200 - 2400 - 4800 - 9600 - 19200 - 38400 – 57600 bps.
CAN connection	Support CAN 2.0B interface (for future use).
USB host connection	For future use.
USB device connection	Available
Temperature probe input connection	Only 2 contacts using 1-wire protocol. - Parasitic supply mode (no need of external power supply) - Connection to more nodes in a daisy chain network - 8 temperature probes connection - 8 meters maximum between RVT to temperature probe or between probes - 64 meters maximum length
Step configuration	Automatic, fixed, disabled.
Display	QVGA 320 x 240 pixels colorful touch-screen.
Adjustable display backlighting	Available
Switching time between steps	Programmable from 1s to 18h.
Saving-function	All programmed parameters and modes are saved in a non-volatile memory.
Auto adaptation to the connection and phase-rotation of the network	

Technical specifications

Auto adaptation to the CT-terminals	
Power Factor correction operation is insensitive to the presence of harmonics.	
Working with passive and regenerative loads (four-quadrant operation).	
Operating temperature	-20° C to 70° C.
Storage temperature	-30° C to 85° C.
Mounting position	Vertical panel mounting.
Dimensions	Front plate: 146 x 146 mm (h x w). Rear side: 205 x 135 mm. Overall: 146 x 211 x 67 mm (h x w x d). Cut out dimensions: 138 x 138 mm (h x w)
Weight	650 g (unpacked).
Connector	Cage clamp type (2.5mm ² single core cable).
Front plate protection	IP 43 (IP54: on request).
Relative humidity	Maximum 95%, non-condensing.
CE and UL marked	

Product line-up

Features	RVT6/RVT12	RVT12 - 3P
Article number	RVT-6TS RVT-12TS	RVT-12TS-3P
1 / 3 phase measurements	1 voltage measurement input 1 current measurement input	3 voltage measurement inputs 3 current measurement inputs
Real time clock	NO	YES
Energy measurements	NO	YES
Ethernet connection	NO	YES
USB host connection	NO	YES
USB device connection	YES	YES
Digital inputs	YES	YES
Alarm / fan relays	YES	YES
Output relays	6 or 12	12
Lock switch	YES	YES
RS485 Modbus connection	YES	YES
External temperature probes	YES	YES

Contact us

Regional offices across Canada

Eastern Region

ABB Inc.

2117 - 32nd Avenue
Lachine QC, H8T 3J1
Phone: +1 514-420-3100
Fax: +1 514-420-3137
Toll-free: 1800-567-0283

Central Region

ABB Inc.

Plaza 5, Suite 500
2000 Argentia Road
Mississauga ON, L5N 2R7
Phone: +1 905-858-1010
Fax: +1 905-858-1080

Western Region

ABB Inc.

9418 - 39th Avenue NW
Edmonton AB, T6E 5T9
Phone: +1 780-447-4677
Fax: +1 780-455-4527

ABB Inc.

4411 - 6th Avenue NW, Suite 110
Calgary AB, T2G 4E8
Phone: +1 403-278-7111
Fax: +1 403-278-8232

British Columbia and Mid-West

ABB Inc.

6531 - 148th Street, Suite 1
Surrey BC, V3S 3C5
Phone: +1 604-598-9811
Fax: +1 604-598-9840

e-mail: pqs_rfq@ca.abb.com

www.abb.ca/lowvoltage

Regional office in USA

ABB Inc.

940 Main Campus Drive
Raleigh NC, 27606
Toll-free: +1888-385-1221

www.abb.com/lowvoltage

While all care has been taken to ensure that the information contained in this publication is correct, no responsibility can be accepted for any inaccuracy. We reserve the right to alter or modify the information contained herein at any time in the light of technical or other developments. Technical specifications are valid under normal operating conditions only. We do not accept any responsibility for any misuse of the product and cannot be held liable for indirect or consequential damages.